

## Mini Multimeter with Non-Contact Voltage Detector (NCV)

### Model EX330

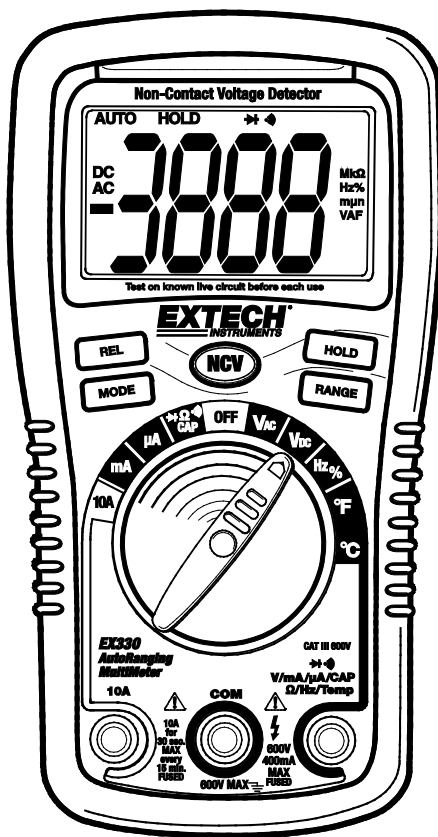



## Introduction

Congratulations on your purchase of the Extech EX330 Meter. The EX330 offers AC/DC Voltage, AC/DC Current, Resistance, Diode, Continuity, non-contact Voltage Detection, Capacitance, Frequency, Duty Cycle, and Temperature (Type K) functions. Proper use and care of this meter will provide many years of reliable service. For copies of this user manual in other languages please visit the [www.extech.com](http://www.extech.com) website.

## Safety



**WARNING**

This symbol adjacent to another symbol, terminal or operating device indicates that the operator must refer to an explanation in the Operating Instructions to avoid personal injury or damage to the meter.

**CAUTION**

This **WARNING** symbol indicates a potentially hazardous situation, which if not avoided, could result in death or serious injury.

This **CAUTION** symbol indicates a potentially hazardous situation, which if not avoided, may result damage to the product.



This symbol advises the user that the terminal(s) so marked must not be connected to a circuit point at which the voltage with respect to earth ground exceeds 600V.

This symbol adjacent to one or more terminals identifies them as being associated with ranges that may, in normal use, be subjected to particularly hazardous voltages. For maximum safety, the meter and its test leads should not be handled when these terminals are energized.

This symbol indicates that a device is protected throughout by double insulation or reinforced insulation.

### SAFETY INSTRUCTIONS

This meter has been designed for safe use but must be operated with caution. The rules listed below must be carefully followed for safe operation.

1. **NEVER** apply voltage or current to the meter that exceeds the specified maximum:

Input Protection Limits	
Function	Maximum Input
V DC or V AC	600V AC and DC
mA AC/DC	500mA DC/AC
A AC/DC	10A DC/AC (for 30 seconds max. every 15 minutes)
Frequency, Resistance, Capacitance, Duty Cycle, Diode Test, Continuity	250V DC/AC
Temperature	250V DC/AC

2. **USE EXTREME CAUTION** when working with high voltages.
3. **DO NOT** measure voltage if the voltage on the "COM" input jack exceeds 600V above earth ground.
4. **NEVER** connect the meter leads across a voltage source while the function switch is in the current, resistance, or diode mode. Doing so can damage the meter.
5. **ALWAYS** discharge filter capacitors in power supplies and disconnect the power when making resistance or diode tests.
6. **ALWAYS** turn off power and disconnect test leads before opening the covers to replace the fuse or battery.
7. **NEVER** operate the meter unless the back cover and the battery and fuse covers are in place and fastened securely.
8. If the equipment is used in a manner not specified by the manufacturer, the protection provided by the equipment may be impaired.

## CAUTIONS

- Improper use of this meter can cause damage, shock, injury, or death. Read and understand this user manual before operating the meter.
- Always remove the test leads before replacing the battery or fuses.
- Inspect the condition of the test leads and the meter itself for any damage before operating the meter. Repair or replace any damage before use.
- Use great care when making measurements if the voltages are greater than 25VAC rms or 35VDC. These voltages are considered a shock hazard.
- Warning! This is a class A equipment. This equipment can cause interference to devices in the home; in this case the operator can be required to carry out adequate measures to prevent interference.
- Always discharge capacitors and remove power from the device under test before performing Diode, Resistance or Continuity tests.
- Voltage checks on electrical outlets can be difficult and misleading because of the uncertainty of connection to the recessed electrical contacts. Other means should be used to ensure that the terminals are not "live".
- If the equipment is used in a manner not specified by the manufacturer, the protection provided by the equipment may be impaired.
- This device is not a toy and must not reach children's hands. It contains hazardous objects as well as small parts that children could swallow. In case a child swallows any of the parts, please contact a physician immediately.
- Do not leave batteries and packing material unattended; they can be dangerous for children.
- In case the device is going to be unused for an extended period, remove the batteries to prevent them from draining.
- Expired or damaged batteries can cause cauterization on contact with skin. Always use suitable hand protection.
- See that the batteries are not short-circuited. Do not dispose of batteries in a fire.

## Description

1. AC Voltage Detector Sensor
2. AC Voltage Detector indicator light
3. LCD
4. RELATIVE push-button
5. MODE button
6. Non-contact AC Voltage Detector test button
7. Rotary function dial
8. 10 ampere test lead jack
9. COM test lead jack
10. Test lead jack for voltage, milli-amp, micro-amp, resistance, capacitance, frequency, and temperature functions
11. RANGE button
12. HOLD button
13. Protective rubber holster (must be removed to access the rear battery compartment)

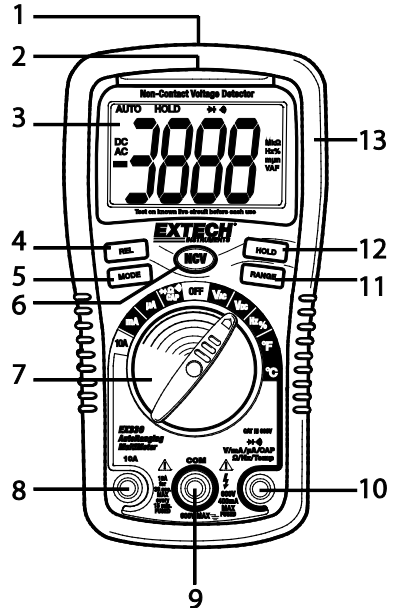

## Display Symbols and Annunciators

n	nano ( $10^{-9}$ ) (capacitance)	$\mu$	micro ( $10^{-6}$ ) (amps, cap)
m	milli ( $10^{-3}$ ) (volts, amps)	A	Amps
k	kilo ( $10^3$ ) (ohms)	F	Farads (capacitance)
M	mega ( $10^6$ ) (ohms)	$\Omega$	Ohms
Hz	Hertz (frequency)	V	Volts
%	Percent (duty ratio)	REL	Relative
AC	Alternating current	AUTO	Autoranging
DC	Direct current	HOLD	Display hold
°F	Degrees Fahrenheit	°C	Degrees Centigrade
•••••	Continuity		
▶	Diode test		
■	Battery status		

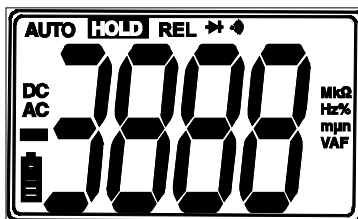

## Operating Instructions

**WARNING:** Risk of electrocution. High-voltage circuits, both AC and DC, are very dangerous and should be measured with great care.

1. ALWAYS turn the function switch to the OFF position when the meter is not in use.
2. Press the HOLD button to freeze a displayed reading

**NOTE:** On some low AC and DC voltage ranges, with the test leads not connected to a device, the display may show a random, changing reading. This is normal and is caused by the high-input sensitivity. The reading will stabilize and give a proper measurement when connected to a circuit.

### NON-CONTACT AC VOLTAGE DETECTOR (NCV)

The EX330 can detect the presence of AC voltage (from 100 to 600VAC) simply by being held very near to a voltage source.

**WARNING:** Test the AC voltage detector on a known live circuit before each use.

**WARNING:** Before using the meter in the AC Voltage Detector mode, verify that the battery is fresh by confirming characters appear on the LCD when the function dial is turned to any position. Do not attempt to use the meter as an AC Voltage Detector if the battery is weak or bad.

The NCV function works on any rotary switch position.

1. Test the detector on a known live circuit before use.
2. Press and hold the NCV button for the duration of the test. The meter will beep once when the button is pushed, and the battery icon will appear briefly before the display goes blank.
3. Hold the top of the meter very close to the voltage source as shown.
4. If voltage is present, the rim of the LCD display will flash a bright orange and an audible warning will sound.



## AC VOLTAGE MEASUREMENTS

**WARNING:** Risk of Electrocution. The probe tips may not be long enough to contact the live parts inside some 240V outlets for appliances because the contacts are recessed deep in the outlets. As a result, the reading may show 0 volts when the outlet actually has voltage on it. Make sure the probe tips are touching the metal contacts inside the outlet before assuming that no voltage is present.

**CAUTION:** Do not measure AC voltages if a motor on the circuit is being switched ON or OFF. Large voltage surges may occur that can damage the meter.

1. Set the function switch to the VAC position.
2. Insert the black test lead banana plug into the negative **COM** jack. Insert red test lead banana plug into the positive **V** jack.
3. Touch the black test probe tip to the neutral side of the circuit.
4. Touch the red test probe tip to the "hot" side of circuit.
5. Read the voltage in the display.
6. If the measured AC voltage exceeds the highest range of the meter (refer to the specification table) an audible tone will sound.

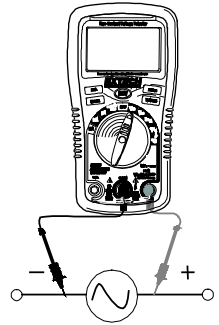

## DC VOLTAGE MEASUREMENTS

**CAUTION:** Do not measure DC voltages if a motor on the circuit is being switched ON or OFF. Large voltage surges may occur that can damage the meter.

1. Set the function switch to the VDC position.
2. Insert the black test lead banana plug into the negative **COM** jack. Insert the red test lead banana plug into the positive **V** jack.
3. Touch the black test probe tip to the negative side of the circuit. Touch the red test probe tip to the positive side of the circuit.
4. Read the voltage in the display.



## AC / DC CURRENT MEASUREMENTS

**CAUTION:** Do not make current measurements at 10 Amps for longer than 30 seconds. Exceeding 30 seconds may cause damage to the meter and/or the test leads.

1. Insert the black test lead banana plug into the negative **COM** jack.
2. For current measurements up to 4000 $\mu$ A, set the function switch to the  $\mu$ A position and insert the red test lead banana plug into the **mA/ $\mu$ A** jack.
3. For current measurements up to 400mA, set the function switch to the mA position and insert the red test lead banana plug into the **mA/ $\mu$ A** jack.
4. For current measurements up to 10A, set the function switch to the 10A range and insert the red test lead banana plug into the **10A** jack.
5. Use the MODE button to select AC or DC current. The display will reflect the selection.
6. Remove power from the circuit under test, then open the circuit at the point where you wish to measure current.
7. Touch the black test probe tip to the negative side of the circuit. Touch the red test probe tip to the positive side of the circuit.
8. Apply power to the circuit.
9. Read the current in the display.

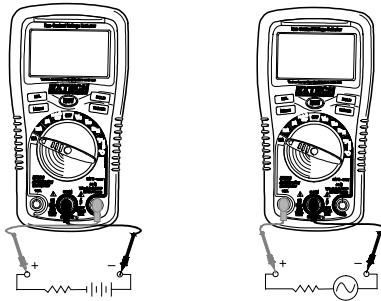

## RESISTANCE MEASUREMENTS

**WARNING:** To avoid electric shock, disconnect power to the unit under test and discharge all capacitors before taking any resistance measurements. Remove the batteries and unplug the line cords.

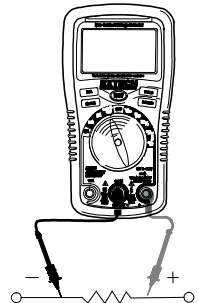

1. Set the function switch to the  $\Omega$  position.
2. Insert the black test lead banana plug into the negative **COM** jack. Insert the red test lead banana plug into the positive  **$\Omega$**  jack.
3. Use the MODE button to view the  $\Omega$  icon on the display.
4. Touch the test probe tips across the circuit or component under test. It is best to disconnect one side of the circuit under test so the rest of the circuit will not interfere with the resistance reading.
5. Read the resistance in the display.







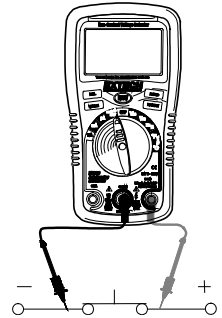

## CONTINUITY CHECK

**WARNING:** To avoid electric shock, never measure continuity on circuits or wires that have voltage on them.

1. Set the function switch to the  position.
2. Insert the black lead banana plug into the negative **COM** jack.
3. Insert the red test lead banana plug into the positive  $\Omega$  jack.
4. Use the MODE button to view the  icon on the display.
5. Touch the test probe tips to the circuit or wire you wish to check.
6. If the resistance is less than approximately  $35\Omega$ , the audible signal will sound. If the circuit is 'open' (bad), the display will indicate "OL".



## DIODE TEST

1. Set the function switch to the  position.
2. Insert the black test lead banana plug into the negative **COM** jack and the red test lead banana plug into the positive  jack.
3. Use the MODE button to view the  icon on the display.
4. Touch the test probes to the diode under test. Forward voltage will typically indicate 0.400 to 0.700V. Reverse voltage will indicate "OL". Shorted devices will indicate near 0V and an open device will indicate "OL" in both polarities.



## CAPACITANCE MEASUREMENTS

**WARNING:** To avoid electric shock, disconnect power to the unit under test and discharge all capacitors before taking any capacitance measurements. Remove the batteries and unplug the line cords.

1. Set the rotary function switch to the CAP position.
2. Insert the black test lead banana plug into the negative **COM** jack.
3. Insert the red test lead banana plug into the positive **CAP** jack.
4. Use the MODE button to view the unit of measurement.
5. Touch the test leads to the capacitor to be tested.
6. The test may take up to 3 minutes or more for large capacitors to charge. Wait until the readings settle before ending the test.
7. Read the capacitance value in the display

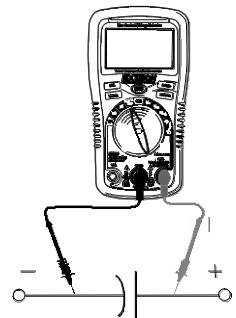

## FREQUENCY MEASUREMENTS

1. Use the MODE button to view the **Hz** unit of measure on the LCD display.
2. Insert the black test lead banana plug into the negative **COM** jack and the red test lead banana plug into the positive **Hz** jack.
3. Touch the test probe tips to the circuit under test.
4. Read the frequency on the display.

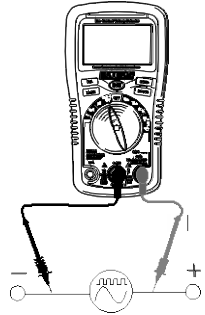

## % DUTY CYCLE

1. Set the rotary function switch to the **Hz/%** position.
2. Use the MODE button to view the **%** unit of measure on the LCD display.
3. Insert the black lead banana plug into the negative **COM** jack and the red test lead banana plug into the positive **Hz** jack.
4. Touch the test probe tips to the circuit under test.
5. Read the % duty cycle on the display.

## CONTACT TEMPERATURE MEASUREMENTS

1. Set the function switch to the °F or °C position.
2. Insert the Temperature Probe into the input jacks, making sure to observe polarity.
3. The probe can be pressed against a device under test to read its temperature or the probe can be held in air to read the ambient temperature. Allow 30 seconds for the display to stabilize.
4. Read the temperature in the display.

Note: The temperature range of the supplied thermocouple probe is -4 to 482°F (-20 to 250°C).



## AUTO-MANUAL RANGE SELECTION

When the meter is first turned on, it automatically goes into the Auto Range mode. This automatically selects the best range for the measurements being made and is generally the best mode for most measurements. For measurement situations requiring that a range be manually selected, perform the following:

1. Press the RANGE key. The **AUTO** display indicator will turn off.
2. Press RANGE to step through the available ranges until the desired range is selected.
3. To exit the Manual Ranging mode and return to Auto Range, press and hold the RANGE key for 2 seconds.

**Note:** Manual range does not apply to Capacitance, Frequency or Temperature modes.

## RELATIVE MODE

The relative measurement feature allows you to make measurements relative to a stored reference value. A reference voltage, current, etc. can be stored so that subsequent measurements can be made in comparison to that value. The displayed value is the difference between the reference value and the measured value.

1. Perform the measurement as described in the operating instructions.
2. Press the REL button to store the reading (the REL indicator will appear on the display).
3. The display will now indicate the difference between stored value and subsequent measurements.
4. Press the REL button to exit the relative mode.

**Note:** The Relative mode is not available when measuring Frequency or Duty Cycle.

## AUTO POWER OFF

The meter will automatically turn off after 15 minutes of inactivity. This will conserve battery energy. To turn the meter on after an Auto Power OFF, simply turn the rotary switch to OFF and then back to the desired setting.

## Maintenance

---

**WARNING:** To avoid electric shock, disconnect the test leads from any source of voltage before removing the back cover or the battery or fuse covers.

**WARNING:** To avoid electric shock, do not operate your meter until the battery and fuse covers are in place and fastened securely.

This MultiMeter is designed to provide years of dependable service, if the following care instructions are performed:

1. **KEEP THE METER DRY.** If it gets wet, dry it immediately.
2. **USE AND STORE THE METER IN NORMAL TEMPERATURES.** Temperature extremes can shorten the life of the electronic parts and distort or melt plastic parts.
3. **HANDLE THE METER GENTLY AND CAREFULLY.** Dropping it can damage the electronic parts or the case.
4. **KEEP THE METER CLEAN.** Wipe the case occasionally with a damp cloth. DO NOT use chemicals, cleaning solvents, or detergents.
5. **USE ONLY FRESH BATTERIES OF THE RECOMMENDED SIZE AND TYPE.** Remove old or weak batteries so they do not leak and damage the unit.
6. **IF THE METER IS TO BE STORED FOR A LONG PERIOD OF TIME,** the batteries should be removed to prevent damage to the unit.

## BATTERY INSTALLATION and LOW BATTERY INDICATION

**WARNING:** To avoid electric shock, disconnect the test leads from any source of voltage before removing the battery cover.

### LOW BATTERY INDICATION

The  icon will appear in the lower left-hand corner of the display when the battery voltage becomes low. Replace the batteries when this appears.

### BATTERY REPLACEMENT

1. Disconnect the test leads from the meter.
2. Remove the protective rubber holster as shown in the diagram.
3. Remove the Phillips head screw located on the lower back of the instrument.
4. Flip up the fuse/battery compartment cover to access the batteries.
5. Gently remove the batteries and install two new 1.5V 'AAA' batteries observing polarity.
6. Secure the fuse/battery compartment cover.
7. Place the protective rubber holster on the meter.

### Battery Safety Reminders

- Please dispose of batteries responsibly; observe local, state, and national regulations.
- Never dispose of batteries in a fire; batteries may explode or leak.
- Never mix battery types; install new batteries of the same type.

**WARNING:** To avoid electric shock, do not operate the meter until the batteries and the fuses are in place and fastened securely.

1. Removable Rubber Holster
2. Meter
3. Battery
4. Fuses
5. Compartment Cover
6. Rubber Holster

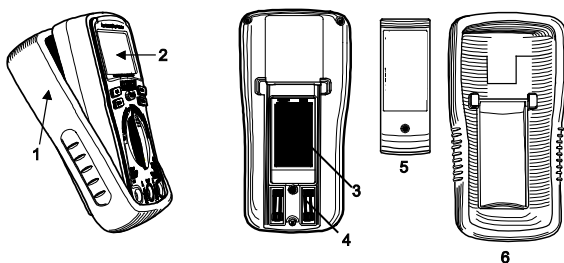

## REPLACING THE FUSES

**WARNING:** To avoid electric shock, disconnect the test leads from any source of voltage before removing the fuse cover.

1. Disconnect the test leads from the meter.
2. Remove the protective rubber holster as shown in the diagram.
3. Remove the Phillips head screw located on the lower back of the instrument.
4. Flip up the fuse/battery compartment cover to access the fuses.
5. Gently remove the fuse(s) and install new fuse(s) into the holder(s).
6. Always use fuses of the proper size and value (500mA/600V fast blow for the mA /  $\mu$ A ranges, 10A/600V fast blow for the A range).
7. Secure the fuse/battery compartment cover.
8. Place the protective rubber holster on the meter.

## Electrical Specifications

Function	Range	Resolution	Accuracy
Non-contact AC Voltage detector	100 to 600VAC	Resolution & accuracy do not apply since the meter does not display the voltage in this mode. The lamp at the top of the meter's display flashes when voltage is sensed.	
DC Voltage (V DC)	400mV	0.1mV	$\pm(0.5\% \text{ reading} + 2 \text{ digits})$
	4V	0.001V	$\pm(1.0\% \text{ reading} + 2 \text{ digits})$
	40V	0.01V	
	400V	0.1V	
	600V	1V	$\pm(1.5\% \text{ reading} + 2 \text{ digits})$
AC Voltage (V AC) (50 / 60Hz)	400mV	0.1mV	$\pm(1.0\% \text{ reading} + 30 \text{ digits})$
	4V	0.001V	$\pm(1.5\% \text{ reading} + 3 \text{ digits})$
	40V	0.01V	
	400V	0.1V	
	600V	1V	$\pm(2.0\% \text{ reading} + 4 \text{ digits})$
DC Current (A DC)	400 $\mu$ A	0.1 $\mu$ A	$\pm(1.0\% \text{ reading} + 3 \text{ digits})$
	4000 $\mu$ A	1 $\mu$ A	$\pm(1.5\% \text{ reading} + 3 \text{ digits})$
	40mA	0.01mA	
	400mA	0.1mA	
	10A	0.01A	$\pm(2.5\% \text{ reading} + 5 \text{ digits})$
AC Current (AAC) (50 / 60Hz)	400 $\mu$ A	0.1 $\mu$ A	$\pm(1.5\% \text{ reading} + 5 \text{ digits})$
	4000 $\mu$ A	1 $\mu$ A	$\pm(1.8\% \text{ reading} + 5 \text{ digits})$
	40mA	0.01mA	
	400mA	0.1mA	
	10A	0.01A	$\pm(3.0\% \text{ reading} + 7 \text{ digits})$

Resistance	400Ω	0.1Ω	±(1.2% reading + 4 digits)
	4kΩ	1Ω	
	40kΩ	0.01kΩ	±(1.2% reading + 2 digits)
	400kΩ	0.1kΩ	
	4MΩ	0.001MΩ	
	40MΩ	0.01MΩ	±(2.0% reading + 3 digits)
Capacitance	4nF	0.001nF	±(3.5% reading + 40 digits)
	40nF	0.01nF	
	400nF	0.1nF	±(2.5% reading + 4 digits)
	4μF	0.001μF	
	40μF	0.01μF	±(3.5% reading + 4 digits)
	200μF	0.1μF	
Frequency	5.000Hz	0.001Hz	±(0.1% reading + 1 digits)
	50.00Hz	0.01Hz	
	500.0 Hz	0.1Hz	
	5.000kHz	0.001kHz	
	50.00kHz	0.01kHz	
	500.0kHz	0.001MHz	
	5.00MHz	0.01MHz	
	10.00MHz	0.01MHz	
	Sensitivity: 0.8V rms min. @ 20% to 80% duty cycle and <100kHz; 5Vrms min @ 20% to 80% duty cycle and > 100kHz.		
Duty Cycle	0.1 to 99.9%	0.1%	±(1.2% reading + 2 digits)
	For duty cycle the pulse width range is 100μs - 100ms (Frequency: 5Hz to 150kHz)		
Temp (Type-K)	-4 to 1382°F	1°F	±(3.0% reading + 8 digits) (probe accuracy not included)
	-20 to 750°C	1°C	

**NOTES:**

Accuracy specifications consist of two elements:

- (% reading) – This is the accuracy of the measurement circuit.
- (+ digits) – This is the accuracy of the analog to digital converter.

Accuracy is stated at 65°F to 83°F (18°C to 28°C) and less than 75% RH.

## General Specifications

---

<b>Diode Test</b>	Test current: 0.3mA max., Open circuit voltage: 1.5V DC typ.
<b>Continuity Check</b>	Audible signal will sound if the resistance is less than 35Ω
<b>Temperature Sensor</b>	Requires Type-K thermocouple
<b>Input Impedance</b>	10MΩ (VDC & VAC)
<b>AC Bandwidth</b>	50 / 60Hz
<b>Display</b>	4000 count (0 to 3999 digits) LCD
<b>Overrange indication</b>	For all functions “OL” is displayed (Note: For ACV measurements only, an audible beep will also sound)
<b>Auto Power Off</b>	After 15 minutes (approximately) of inactivity
<b>Polarity</b>	No indication for positive; Minus (-) sign for negative
<b>Measurement Rate</b>	2 times per second, nominal
<b>Low Battery Indication</b>	“  ” is displayed if battery voltage is critically low
<b>Battery</b>	Two (2) 1.5V ‘AAA’ batteries
<b>Fuses</b>	mA, μA ranges: 500mA/600V fast blow; 'A' range: 10A/600V fast blow
<b>Operating Temperature</b>	32°F to 122°F (0°C to 50°C)
<b>Storage Temperature</b>	-4°F to 140°F (-20°C to 60°C)
<b>Operating Humidity</b>	<70% RH
<b>Storage Humidity</b>	<80% RH
<b>Operating Altitude</b>	7000 ft. (2000 m) maximum.
<b>Weight</b>	9.17 oz (260 g) (includes holster).
<b>Size</b>	5.8” x 2.9” x 1.6 in. (147 x 76 x 42 mm) (includes holster)
<b>Approvals</b>	CE
<b>Safety</b>	This meter is intended for indoor use and protected, against the users, by double insulation per EN61010-1 and IEC61010-1 3 <sup>rd</sup> Edition (2010) to CAT III 600V; Pollution Degree 2.

### PER IEC1010 OVERVOLTAGE INSTALLATION CATEGORY

#### OVERVOLTAGE CATEGORY I

Equipment of OVERVOLTAGE CATEGORY I is equipment for connection to circuits in which measures are taken to limit the transient overvoltages to an appropriate low level. Note – Examples include protected electronic circuits.

#### OVERVOLTAGE CATEGORY II

Equipment of OVERVOLTAGE CATEGORY II is energy-consuming equipment to be supplied from the fixed installation.

Note – Examples include household, office, and laboratory appliances.

#### OVERVOLTAGE CATEGORY III

Equipment of OVERVOLTAGE CATEGORY III is equipment in fixed installations.

Note – Examples include switches in the fixed installation and some equipment for industrial use with permanent connection to the fixed installation.

#### OVERVOLTAGE CATEGORY IV

Equipment of OVERVOLTAGE CATEGORY IV is for use at the origin of the installation.

Note – Examples include electricity meters and primary over-current protection equipment

## ***Two-year Warranty***

---

*Teledyne FLIR warrants this Extech brand instrument to be free of defects in parts and workmanship for two years from date of shipment (a six-month limited warranty applies to sensors and cables). To view the full warranty text please visit: <http://www.extech.com/support/warranties>.*

## ***Calibration and Repair Services***

---

Teledyne FLIR offers calibration and repair services for the Extech brand products we sell. We offer NIST traceable calibration for most of our products. Contact us for information on calibration and repair availability, refer to the contact information below. Annual calibrations should be performed to verify meter performance and accuracy. Product specifications are subject to change without notice. Please visit our website for the most up-to-date product information: [www.extech.com](http://www.extech.com).

## ***Contact Customer Support***

---

Customer Support Telephone List: <https://support.flir.com/contact>

Calibration, Repair, and Returns: [repair@extech.com](mailto:repair@extech.com)

Technical Support: <https://support.flir.com>

**Copyright © 2022 Teledyne FLIR Commercial Systems, Inc.**

All rights reserved including the right of reproduction in whole or in part in any form

**[www.extech.com](http://www.extech.com)**

This document does not contain any export-controlled information.