

EXTECH[®]

USER MANUAL

Vane Thermo-Anemometer / Datalogger

Model SDL310



Introduction

Congratulations on your purchase of the Extech SDL310 Thermo-Anemometer Datalogger. This meter displays and stores air velocity and temperature readings. Temperature readings from the thermometer built into the vane probe or from an externally connected type K or J thermocouple temperature probe can be displayed and recorded. Data is stored on an SD card for transfer to a PC. In addition, an RS232 port allows data streaming to a PC. This meter is shipped fully tested and calibrated and, with proper use, will provide years of reliable service.



Safety

International Safety Symbols



This symbol, adjacent to another symbol or terminal, indicates the user must refer to the manual for further information.

Meter Description

1. Thermocouple input
2. Vane input plug
3. Air velocity reading
4. Units of measure
5. HOLD / Backlight  key
6. MAX-MIN key
7. SET and Clock  key
8. PC interface jack
9. Reset key
10. Power Adaptor jack
11. SD card slot
12. ENTER and LOG key
13. Down ▼ arrow and FUNCTION key
14. Up ▲ arrow and UNITS key
15. Power ON-OFF  key
16. Temperature reading with units of measure
17. Anemometer vane
18. Colored dot faces the air flow
19. Vane handle
20. Vane connecting cable

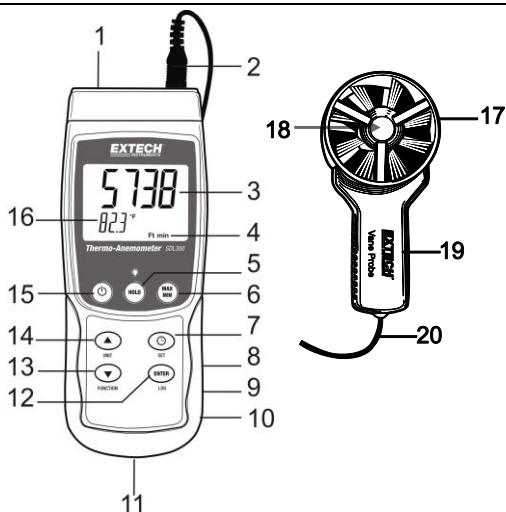

Notes:

Battery compartment, tilt stand, and tripod mount are located on the rear of the instrument.

Items 8, 9, and 10 are located behind the snap-off compartment cover on right side of meter.

Operation

Power ON-OFF

- Power the meter by pressing and holding the power key  for at least 1.5 seconds.
- Press and hold the power key for at least 1.5 seconds to power OFF the meter.

Meter Functions

This meter has two modes of operation. Press and hold the FUNCTION key for at least 1.5 seconds to switch from one mode to the other.

- Air Velocity plus Temperature mode (meter briefly displays **An** icon)
- Type K or J thermocouple temperature mode (meter briefly displays **tP** icon)

Air Velocity plus Temperature Mode

1. Select the Air Velocity and Temperature mode.
2. Connect the vane probe to the meter's probe jack (top right of meter) via the probe plug.
3. Hold the probe by its handle and allow the air flow to enter the vane. Note that the air flow must face the vane's colored dot.
4. The meter will display the air velocity measurement (upper display area) and the air temperature (lower display area)

Changing the Air Velocity Unit of Measure

This meter offers five (5) units of measure selections for air velocity: m/s (meters per second), FPM (feet per minute), Km/h (kilometers per hour), knots, and mph (miles per hour).

1. Press and hold the UNIT key for at least 1.5 seconds to switch from one unit of measure to another.
2. Note that pressing and holding the UNIT key continuously allows for quicker scrolling. Release the key when the desired unit of measure is displayed.

Thermocouple (Type J or K) Temperature Mode

1. Select the Thermocouple Temperature mode using the FUNCTION button.
2. The meter will display a 'J' or a 'K'; on the left side of the display indicating the current setting. To change the thermocouple type, refer to the Setup Mode section.
3. Connect a Type J or Type K thermocouple to the meter's sub-miniature thermocouple jack (top of meter on the left).
4. Hold the thermocouple in the air in the area to be tested.
5. The meter will display the thermocouple temperature in the main display area.
6. To change the temperature unit of measure (°C and °F) refer to the Setup Mode section.

Data Hold

To freeze a measurement on the display, press the HOLD key momentarily. The meter will emit a beep, the reading will hold, and the HOLD display icon will switch on. Press the HOLD key again to release the display and exit the Data Hold mode returning the meter to the normal operating mode.

MAX-MIN Readings

For a given measurement session, this meter can record the highest (MAX) and the lowest (MIN) readings for later recall.

1. Press the MAX-MIN key momentarily to access this mode of operation (REC icon appears)
2. The meter is now recording the MAX and MIN readings.
3. Press the MAX-MIN key again to view the current MAX reading (MAX icon appears). The reading on the display is now the highest reading encountered since the REC icon was switched on (when the MAX-MIN key was first pressed).
4. Press the MAX-MIN key again to view the current MIN reading (MIN icon appears). The reading on the display is now the lowest reading encountered since the REC icon was switched on (when the MAX-MIN key was first pressed).
5. To exit the MAX-MIN mode, press and hold the MAX-MIN key for at least 1.5 seconds. The meter will beep, the REC-MAX-MIN icons will switch off, the memory will clear, and the meter will return to the normal operating mode.

Display Backlight

To turn the display backlight ON or OFF, press and hold the backlight  key for at least 1.5 seconds. The meter will beep when switching the backlight ON or OFF unless the beeper is disabled as described in the Setup Mode section of this user guide.

System Reset

If the meter's keys become inoperable or if the display freezes, the Reset button can be used to reset the instrument.

1. Use a paper clip or similar item to momentarily press the reset button located on the lower right side of the instrument under the snap-off compartment cover.
2. After pressing the Reset button, switch the instrument ON by pressing and holding the POWER key for at least 1.5 seconds. If using the power adaptor, unplug the adaptor and then plug it back in again to power the meter.

AC Power Adaptor

This meter is normally powered by six (6) 1.5V 'AA' batteries. However, an optional AC 9V power adaptor is available. To use the adaptor, insert the power adaptor plug into the jack on the bottom right side of the meter (under the snap-off compartment cover); plug the other end of the adaptor into an AC power source. The meter will now be permanently powered (as long as the adaptor is used) and the power key will be disabled.

Datalogger

Types of Data Recording

- **Manual Datalogging:** Manually log up to 99 readings onto an SD card via push-key press.
- **Automatic Datalogging:** Automatically log data onto an SD memory card where the number of data points is limited only by the card size. Readings are logged at a rate specified by the user.

SD Card Information

- Insert an SD card (from 1G size up to 16G) into the SD card slot at the bottom of the meter. With regard to orientation, the card should be inserted with the front of the card (label side) facing toward the rear of the meter.
- If the SD card is being used for the first time it is recommended that the card be formatted and the logger's clock set to allow for accurate date/time stamping during datalogging sessions. Refer to the Setup Mode section for SD card formatting and time/date setting instructions.
- European and USA numerical formats differ. The data on the SD card can be formatted for either format. The meter defaults to USA mode where a decimal point is used to separate units from tenths, i.e. **20.00**. The European format uses a comma, i.e. **20,00**. To change this setting, refer to the Setup Mode section.

Manual Datalogging

In the manual mode the user presses the LOG key to manually log a reading onto the SD card.

1. Set the sampling rate to '0' seconds.
2. Press and hold the LOG key for at least 1.5 seconds; the lower portion of the display will show p-n (n = memory position number 1-99).
3. Press the LOG key momentarily to log a reading into memory. The REC icon will flash each time a data point is stored (the SCAN SD icon will appear when the meter accesses the card).
4. Use the ▲ and ▼ keys to select one of the 99 data memory positions in which to record.
5. To exit the manual datalogging mode, press and hold the LOG key for at least 1.5 seconds.

Automatic Datalogging

In automatic datalogging mode the meter takes and stores a reading at a user-specified sampling rate onto SD card. The meter defaults to a sampling rate of one second. To change the sampling rate, refer to the Setup Mode section (the sampling rate cannot be '0' for automatic datalogging):

1. To begin an automatic Datalog session press and hold the LOG key for at least 1.5 seconds.
2. The meter will scan for an SD card and verify that it can be used to store data. If a card is not inserted or if the card is defective, the meter will display SCAN SD indefinitely. In this case, switch the meter OFF and try again with a valid SD card.
3. If the SD card is valid, the display will show the LOG icon (or the LOG icon alternating with the temperature display) and then the REC icon will flash each time that a reading is stored.
4. To pause the datalogger, press the LOG key momentarily. The REC icon will stop flashing. To resume logging simply press the LOG key again momentarily.
5. To terminate the datalogging session press and hold the LOG key for at least 1.5 seconds.
6. When an SD card is used for the first time a folder is created on the card and named **AMC01**. Up to 99 spreadsheet documents (each with 30,000 readings) can be stored in this folder.
7. When datalogging begins a new spreadsheet document named **AMC01001.xls** is created on the SD card in the AMC01 folder. The data recorded will be placed in the AMC01001.xls document until 30,000 readings are reached.
8. If the measurement session exceeds 30,000 readings, a new document will be created (AMC01002.xls) where another 30,000 readings can be stored. This method continues for up to 99 documents, after

which another folder is created (AMC02) where another 99 spreadsheet documents can be stored. This process continues in this same fashion with folders AMC03 through AMC10 (last allowable folder).

SD Data Card to PC Data Transfer

1. Complete a datalogging session as covered above. For the first test, simply record a small amount of test data.
2. With the meter switched OFF, remove the SD Card.
3. Plug the SD Card directly into a PC SD card reader. If the PC does not have an SD card slot, use an SD card adaptor (available at most outlets where computer accessories are sold).
4. Power the PC and run a spreadsheet software program. Open the saved documents in the spreadsheet software program (see examples of spreadsheet displays below).

Spreadsheet data example

1	Place	Date	Time	Value	Unit	Value	Unit
2	1	2009/6/8	15:12:16	0.8	m/s	28.8	AMTemp C
3	2	2009/6/8	15:12:17	2.2	m/s	28.8	AMTemp C
4	3	2009/6/8	15:12:18	2.1	m/s	28.8	AMTemp C
5	4	2009/6/8	15:12:19	2.9	m/s	28.9	AMTemp C
6	5	2009/6/8	15:12:20	2.9	m/s	28.8	AMTemp C
7	6	2009/6/8	15:12:21	2.7	m/s	28.8	AMTemp C
8	7	2009/6/8	15:12:22	3.6	m/s	28.8	AMTemp C
9	8	2009/6/8	15:12:23	2.9	m/s	28.8	AMTemp C
10	9	2009/6/8	15:12:24	2.9	m/s	28.8	AMTemp C
11	10	2009/6/8	15:12:25	2.9	m/s	28.8	AMTemp C
12	11	2009/6/8	15:12:26	2.9	m/s	28.9	AMTemp C
13	12	2009/6/8	15:12:27	3	m/s	28.8	AMTemp C
14	13	2009/6/8	15:12:28	3.1	m/s	28.8	AMTemp C
15	14	2009/6/8	15:12:29	3.1	m/s	28.7	AMTemp C
16	15	2009/6/8	15:12:30	5.9	m/s	29.1	AMTemp C
17	16	2009/6/8	15:12:31	4.2	m/s	29	AMTemp C
18	17	2009/6/8	15:12:32	3.2	m/s	28.9	AMTemp C
19	18	2009/6/8	15:12:33	2.6	m/s	28.6	AMTemp C
20	19	2009/6/8	15:12:34	3.1	m/s	28.7	AMTemp C
21	20	2009/6/8	15:12:35	3	m/s	28.7	AMTemp C
22	21	2009/6/8	15:12:36	3	m/s	28.9	AMTemp C
23	22	2009/6/8	15:12:37	3.1	m/s	28.9	AMTemp C
24	23	2009/6/8	15:12:38	2.8	m/s	28.9	AMTemp C

Spreadsheet example (Plotting the data)

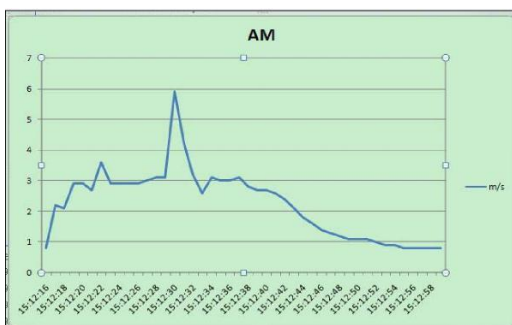

RS-232/USB PC Interface

For streaming of data to a PC via the RS232 Output jack, the optional 407001-USB kit along with the 407001-PRO software (available free at www.extech.com/software/downloads) are required.

Setup Mode

Basic settings at a glance

To view the current configuration of the meter with regard to time, date, thermocouple type, and datalogging sampling rate, press the SET/CLOCK ICON key momentarily. The meter will now display the configuration in quick succession. Repeat as necessary to observe all of the information.

Accessing the Setup mode

1. Press and hold the SET key for at least 1.5 seconds to access the Setup menu.
2. Press the SET key momentarily to step through the available parameters. The parameter type is shown on the bottom of the LCD and the current selection for that type is shown above it.
3. When a parameter is displayed that is to be changed, use the arrow keys to change the setting. Press the ENTER key to confirm a change.
4. Press and hold the SET key for at least 1.5 seconds to exit the Setup mode. Note that the meter automatically switches out of the Setup mode if no key is pressed in 7 seconds while in the Setup mode.
5. The available Setup parameters are listed below. Additional detailed information is provided below this list:

dAtE Set the clock time (Year/Month/Date; Hour/Minute/Second)

SP-t Set the datalogger sampling rate (1 to 3600 seconds)

PoFF Automatic power-off management

bEEP Set beeper sound ON/OFF

dEC Set SD card Decimal character (comma for European format)

SdF SD memory card Format

t-CF Select the Temperature unit of measure to C or F

tYPE Select the thermocouple type to K or J

Setting the Clock Time

1. Access the **dAtE** parameter.
2. Use the arrow keys to change a value
3. Use the ENTER button to step through the selections
4. Press and hold the SET button for at least 1.5 seconds to exit to the normal operation mode (or simply wait 7 seconds for the meter to automatically switch to the normal operating mode).
5. The clock will keep accurate time even when the meter is switched off. However, if the battery expires the clock will have to be reset after fresh batteries are installed.

Setting the Datalogger Sampling Time (Rate)

1. Access the **SP-t** parameter.
2. Use the arrow keys to select the desired sampling rate. The available settings are: 0, 1, 2, 5, 10, 30, 60, 120, 300, 600, 1800, and 3600 seconds.
3. Press the ENTER key to confirm the entry.
4. Press and hold the SET key for at least 1.5 seconds to exit to the normal operation mode (or simply wait 7 seconds for the meter to automatically switch to the normal operating mode).

Enabling/Disabling the Auto Power OFF Feature

1. Access the **PoFF** parameter .

2. Use the arrow keys to select ON (enable) or OFF (disable). With the Auto Power OFF feature enabled, the meter will automatically switch OFF after 5 minutes of inactivity.
3. Press ENTER to confirm setting.
4. Press and hold the SET key for at least 1.5 seconds to exit to the normal operation mode (or simply wait 7 seconds for the meter to automatically switch to the normal operating mode).

Set the Beeper Sound ON or OFF

1. Access the **bEEP** parameter.
2. Use the arrow keys to select ON (enable) or OFF (disable).
3. Press ENTER to confirm setting.
4. Press and hold the SET key for at least 1.5 seconds to exit to the normal operation mode (or simply wait 7 seconds for the meter to automatically switch to the normal operating mode).

Numerical Setting (comma or decimal)

European and USA numerical formats differ. The meter defaults to USA mode where a decimal point is used to separate units from tenths, i.e. **20.00**; European formats use a comma, i.e. **20,00** to separate units from tenths. To change this setting:

1. Access the **dEC** parameter as described in the Accessing Setup Mode section above.
2. Use the arrow keys to select USA or EUro.
3. Press ENTER to confirm setting.
4. Press and hold the SET key for at least 1.5 seconds to exit to the normal operation mode (or simply wait 7 seconds for the meter to automatically switch to the normal operating mode).

SD Card FORMATTING

1. Access the **Sd-F** parameter.
2. Use the arrow keys to select YES to format the card (select NO to abort). Note that all data on the card will be lost if formatting is attempted.
3. Press ENTER to confirm selection.
4. Press ENTER again to re-confirm.
5. The meter will automatically return to the normal operating mode when formatting is complete. If not, press and hold the SET key for at least 1.5 seconds to exit to the normal operation mode.

Set the Temperature Units of Measure (°C or °F)

1. Access the **t-CF** parameter.
2. Use the arrow keys to select °C or °F.
3. Press ENTER to confirm setting.
4. Press and hold the SET key for at least 1.5 seconds to exit to the normal operation mode (or simply wait 7 seconds for the meter to automatically switch to the normal operating mode).

Set the Temperature Thermocouple Type (J or K)

1. Access the **tYPE** parameter.
2. Use the arrow keys to select J or K.
3. Press ENTER to confirm setting.
4. Press and hold the SET key for at least 1.5 seconds to exit to the normal operation mode (or simply wait 7 seconds for the meter to automatically switch to the normal operating mode).

Battery Replacement

When the low battery  icon appears on the LCD, the batteries must be replaced. Several hours of accurate readings are still possible in this condition; however batteries should be replaced as soon as possible:

1. Remove the two (2) Phillips screws from the rear of the meter (directly above the top of the tilt stand).
2. Remove and safely place the battery compartment and screws where they will not be damaged or lost.
3. Replace the six (6) 1.5V 'AA' batteries observing polarity.
4. Replace the battery compartment cover with the two (2) Phillips screws.

Specifications

General Specifications

Display	Backlit LCD; LCD size: 2 x 1.5" (52 x 38mm)
Measurement Units	Air velocity: m/S (meters per second) Km/h (kilometers per hour) Ft/min (FPM; feet per minute), Knots (nautical miles per hour), Mile/h (mph; miles per hour) Air temperature: °C / °F Type K / Type J thermocouple: °C / °F
Datalogger Sampling Rate	AUTO: 1, 2, 5, 10, 30, 60, 120, 300, 600, 1800, 3600 seconds. Note that a one (1) second sampling rate can cause some data loss on slower computers. MANUALLY: Set the sampling rate to '0'
Memory Card	SD memory card; 1G to 16GB size
Temperature Compensation	Automatic temperature compensation for the Anemometer function and the type K/J thermometer function
Data Hold	Freeze the display reading
Memory Recall	Record and Recall the Maximum and Minimum readings
Display update rate	Approx. 1 second
Data Output	RS-232 / USB PC computer interface
Operating Temperature	32 to 122°F (0 to 50°C)
Operating Humidity	85% R.H. max.
Auto Power OFF	After 10 minutes of inactivity (can be disabled)
Power Supply	Six (6) 1.5VDC batteries (optional 9V AC adaptor)
Power Consumption	Normal operation (backlight & datalogger OFF): Approx. 15 mA dc With backlight OFF and datalogging ON: Approx. 36 mA dc
Weight	0.76 lbs. (347g); meter only
Dimension	Main instrument: 7.1 x 2.9 x 1.9" (182 x 73 x 47.5mm) Anemometer sensor head: 2.8" (72mm) diameter

Electrical Specifications (Ambient Temperature 23°C ± 5°C)

Air velocity

Measurement	Range	Resolution	Accuracy
m/S	0.4 - 25.0 m/s	0.1 m/S	± (2% rdg + 0.2 m/S)
Km/h	1.4 - 90.0 km/h	0.1 Km/h	± (2% rdg + 0.8 Km/h)
mph (Mile/h)	0.9 - 55.9 mile/h	0.1 mph	± (2% rdg + 0.4 mph)
Knots	0.8 - 48.6 knots	0.1 Knots	± (2% rdg + 0.4 Knots)
FPM (Ft/min)	80 - 4930 ft/min	1 FPM	± (2% rdg + 40 FPM)

Air temperature

Measuring Range	0 to 50°C (32 to 122°F)
Resolution	0.1°C (0.1 °F)
Accuracy	± 0.8°C (1.5°F)

Type K/J Thermocouple Thermometer Temperature

Sensor Type	Resolution	Range	Accuracy
Type K	0.1°C	-50.0 to 1300.0°C -100.0° to -50.1C	± (0.4% rdg + 0.5°C) ± (0.4% rdg + 1°C)
	0.1°F	-58.0 to 2372.0°F -148.0 to -58.1°F	± (0.4% rdg + 1°F) ± (0.4% rdg + 1.8°F)
Type J	0.1°C	-50.0 to 1200.0°C -100.0 to -50.1°C	± (0.4% rdg + 0.5°C) ± (0.4% rdg + 1°C)
	0.1°F	-58.0 to 2192.0°F -148.0 to -58.1°F	± (0.4% rdg + 1°F) ± (0.4% rdg + 1.8°F)

Note: Above specifications tested under an environmental RF Field Strength lower than 3 V/M and a frequency lower than 30 MHz

Three-year Warranty

Teledyne FLIR warrants this Extech brand instrument to be free of defects in parts and workmanship for **three years from date of shipment (a six-month limited warranty applies to sensors and cables). To view the full warranty text please visit:**

<https://www.flir.com/support-center/warranty/instruments/extech-product-warranty/>.

Calibration and Repair Services

Teledyne FLIR offers calibration and repair services for the Extech brand products we sell. We offer NIST traceable calibration for most of our products. Contact us for information on calibration and repair availability, refer to the contact information below. Annual calibrations should be performed to verify meter performance and accuracy. Product specifications are subject to change without notice. Please visit our website for the most up-to-date product information:

www.flir.com/landing/extech/.

Contact Customer Support

Customer Support - Local Telephone List:

<https://support.flir.com/contact>

Obtain a Return Material Authorization (RMA):

<https://customer.flir.com/Home>

Contact Customer Service:

<https://support.flir.com/ContactService>

Technical Support Center:

<https://support.flir.com>

Copyright © 2023 Teledyne FLIR Commercial Systems, Inc.

All rights reserved including the right of reproduction in whole or in part in any form

www.extech.com

This document does not contain export-controlled information

